



CM 300

Gru idraulica a montaggio rapido
Hydraulic crane with quick assembling
Grue hydraulique à montage rapide
Hydraulischer Schnellmontagekran
Grúa hidráulica de montaje rápido



EN 14439 C25

FEM 1.001-A3

PROGETTO e COSTRUZIONE / DESIGN and CONSTRUCTION:
LUIGI CATTANEO S.p.A

CM 300



Nessun componente elettrico sul braccio e sulle parti alte della gru
No electrical component on the jib and the top of the crane

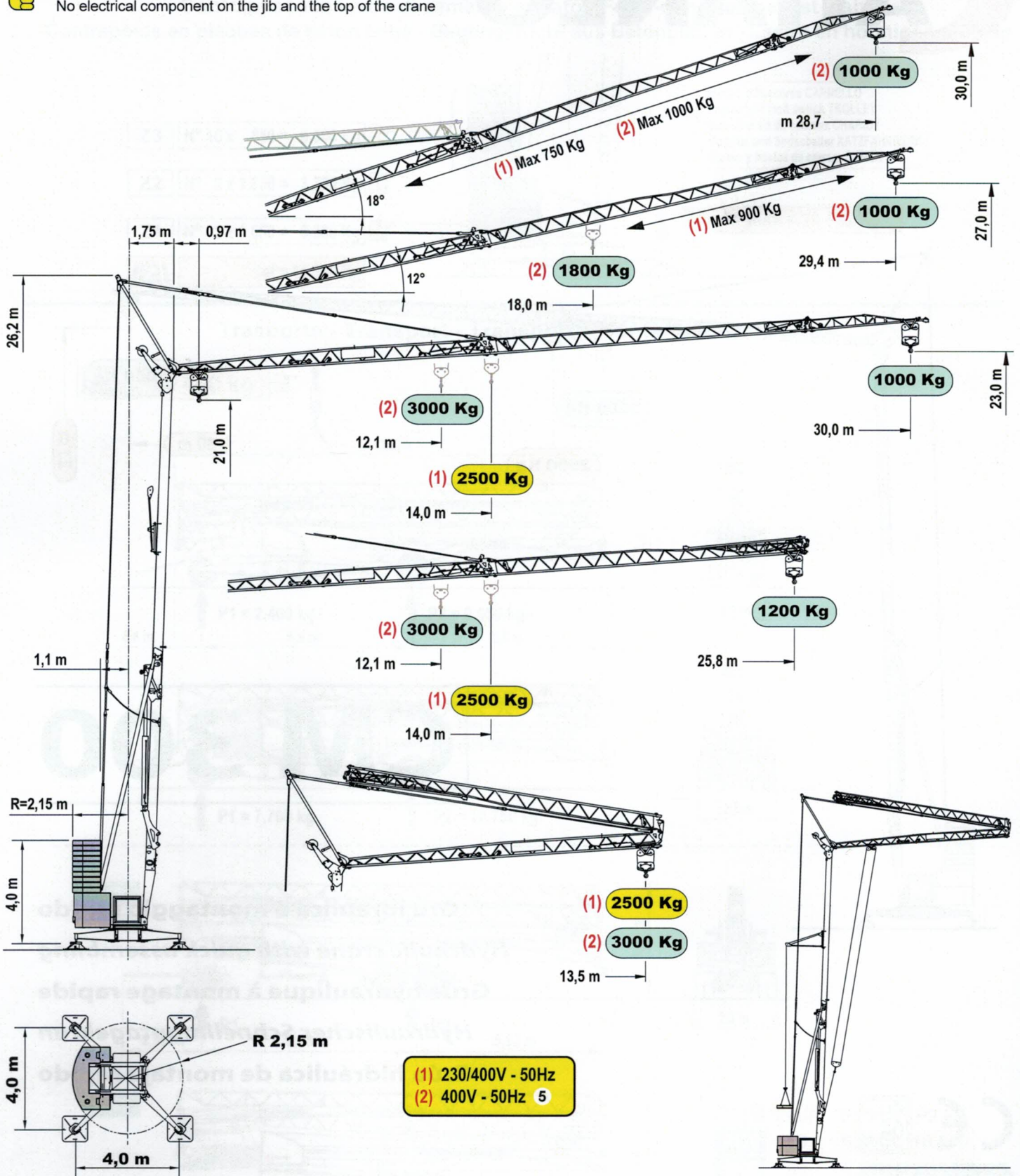

		(2)	(1)					
Curve di carico	kg	3000	2500	2000	1800	1500	1200	1000
Load diagrams	m	12.1	14.0	16.8	18.3	21.5	25.8	30.0
Courbes de charge	m	12.1	14.0	16.8	18.3	21.5	25.8	
Lastkurven	m	12.1	14.0	16.8	18.3	21.5	25.8	
Curvas de cargas	m	13.5	13.5					

Prestazioni - Performances - Prestations - Leistungen - Prestaciones

Icona	kVA	230V - 50Hz			230V - 50Hz			400V - 50Hz			
			(3 kW) 1	4,5 kW 2		(6 kW) 3	10 kW 4				
Inverter	7,5	↑	m/min.	5	18 (12)	26 (18)	↑	m/min.	5	16 (12)	40 (32)
			kg	2.500	1.000	600		kg	2.500	2.500	600
		↓	m/min.	5	18	40	↓	m/min.	5	18	40
			kg	2.500	2.500	1.000		kg	2.500	2.500	1.000
Inverter	1,8	m/min. 20 - 35			m/min. 20 - 40						
Inverter	2,2	g/min. 0,4 - 0,9			g/min. 0,4 - 0,9						

Icona	kVA	400V - 50Hz 15 kW 5					
			1°	2°	3°	4°	
Inverter	11	↑	m/min.	5	18	32	45
			kg	3.000	3.000	1.500	1.000
		↓	m/min.	5	18	32	45
			kg	3.000	3.000	1.000	1.000
Inverter	3	m/min. 25 - 50					
Inverter	2,2	g/min. 0,4 - 0,9					

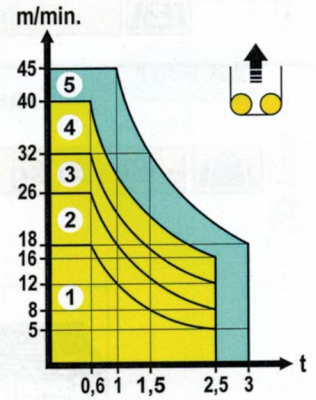

Montaggio - Erection - Montage - Montage - Montaje

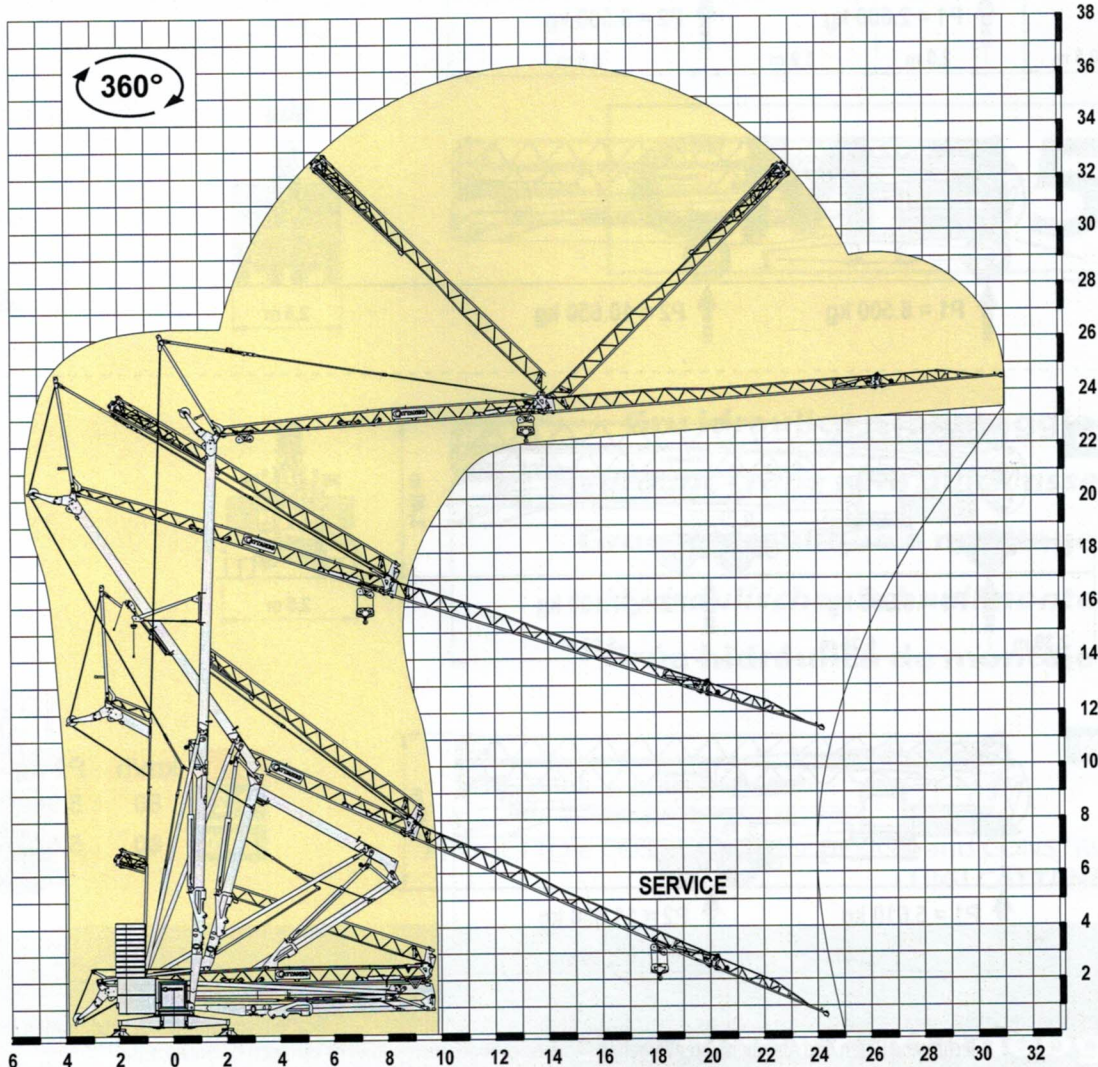

CM 300

Contrappeso in lastre di cemento armato - Ferro-concrete ballast slabs
 Contrepoids en plaques de béton armé - Gegengewicht aus Betonplatten - Lastre en hormigón armado

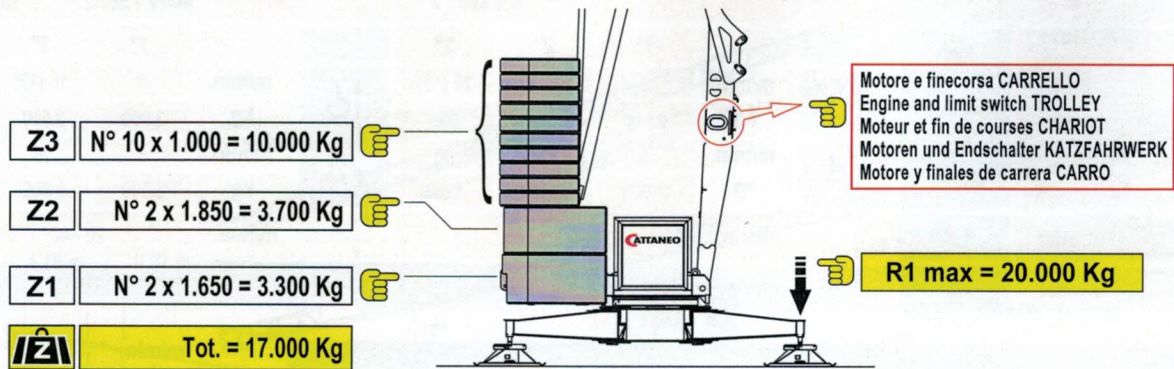

Trasporto - Transport - Transport - Transport - Transporte

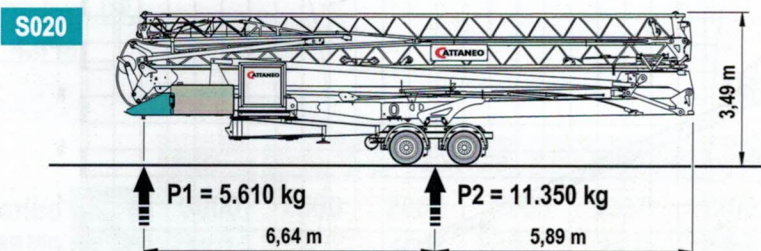
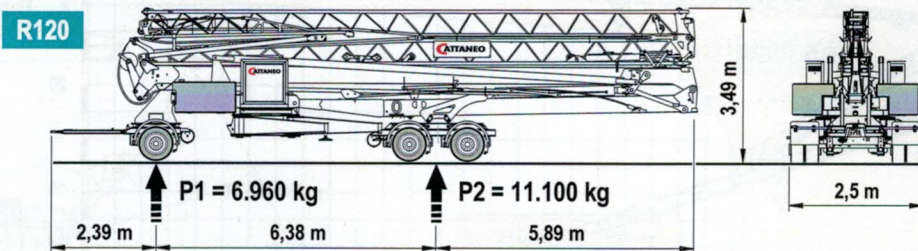
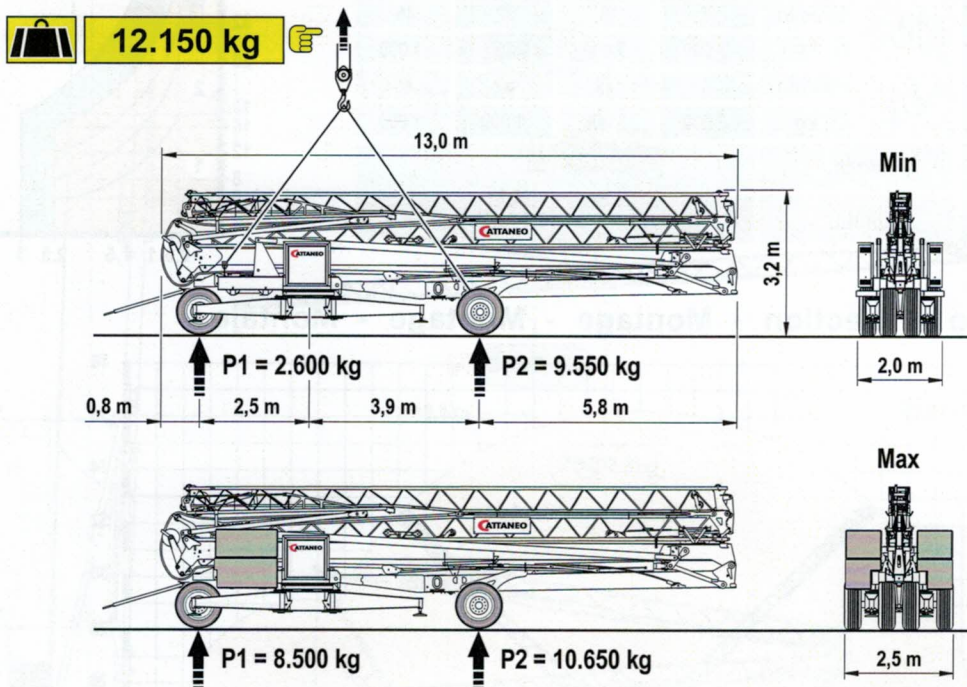

Otto	km/h	P1 kg	P2 kg
R120	80	6.960	11.100
S020	80	5.610	11.350

Dir. 2007/46/CE